

SEC. A-A

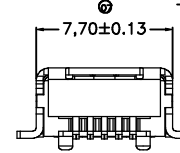

RECOMMEND P.C.B LAYOUT (TOLERANCES ±0.05mm)
(COMPONENT SIDE) THICKNESS=1.2mm

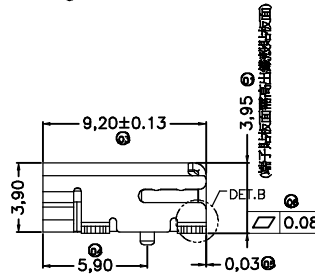
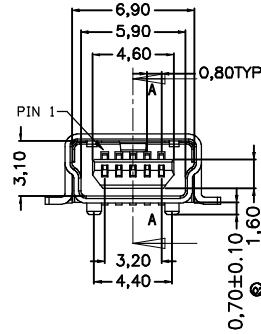
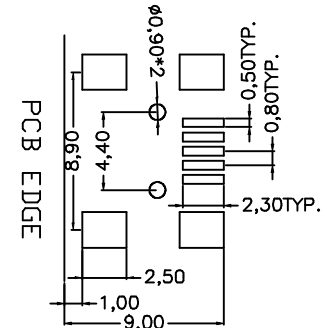
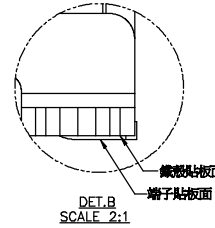
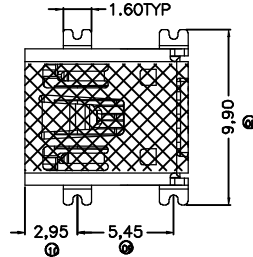
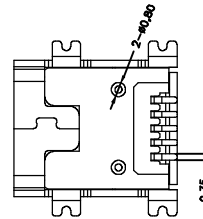
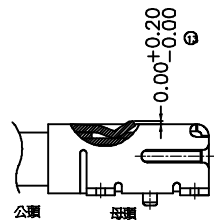

ELECTRICAL CHARACTERISTIC
 Contact current rating: 1.0 Amper.
 Dielectric withstanding Voltage: 100V AC.
 Insulation Resistance: 100 Megohms Min.
 Contact Resistance: 50 milliohms Max.
 Operating Temperature: 0°C to +50°C.
 MECHANICAL CHARACTERISTICS:
 Intervene Force: 35N .Max.
 Separation Force: 7N .Min.
 Singularity Retentivity: 4N .Min .

GENERAL TOLERANCE				HT HUNG TA H.T.ENTERPRISE CO.,LTD			
General		Angle		TITLE:			
X.	±0.38	X°	±3.0°	MINI USB 5P SMT			
.X	±0.30	.X°	±2.0°	PART NO:			
.XX	±0.25	.XX°	±1.0°	K-UAR104-051CM50			
.XXX	±0.10	.XXX°	±0.5°	UNIT:mm		SCALE:1:1	
No.		DATE		DESCRIPTION		APPROVE	

CHECKED		APPROVED		REV:A	
1	2	3	4	5	6