

REV. A

MODEL: RD830G-□A1
X

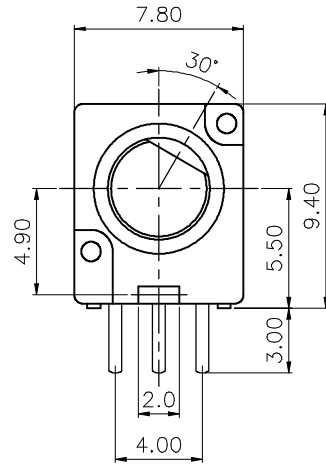

shaft shown in full
C.C.W. position

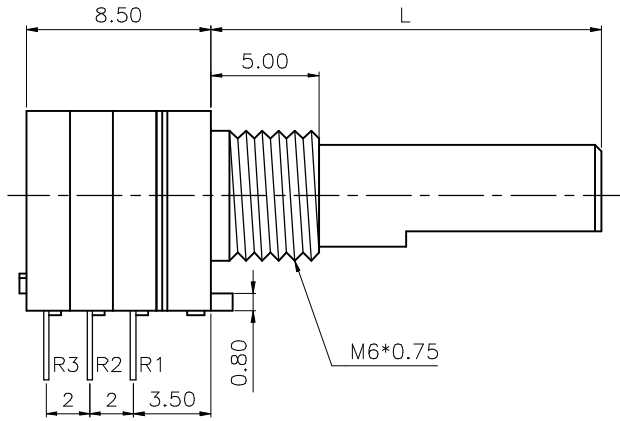
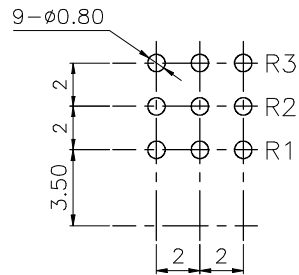

Mounting hole detail

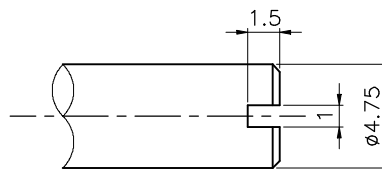
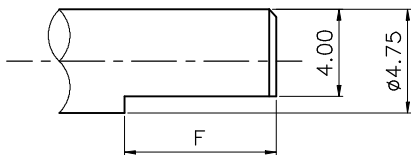

F TYPE:

X	H	F	A	J	G	B	C
L	10	12	15	15	18	20	25
F	3.5	5	7	9	9	12	12

S TYPE:

X	Q	R	S
L	15	20	25

MODEL: RD8□□G-□A1

Mechanical characteristics:機械的性能:

Item<項目>	Performance<性能>
Total rotational angle 全迴轉角度	300°±10°
Rotation torque 迴轉扭力	10~80 gf-cm
Shaft rotational stopper strength 軸的止迴轉強度	3 kgf-cm
Click position C.C.位置	Center click
Click torque C.C.扭力	20~150 gf-cm
Push-pull strength 軸推拉強度	push=5 kgf pull=3 kgf

Electrical characteristics:電氣的性能:

Item<項目>	Performance<性能>
Resistance taper 阻值線性	A/B/C

Reference: Standard resistance tapers in reference to rotational angles(travel) are as shown below:
參考:標準阻值曲線及旋轉角度(行程)表示如下:

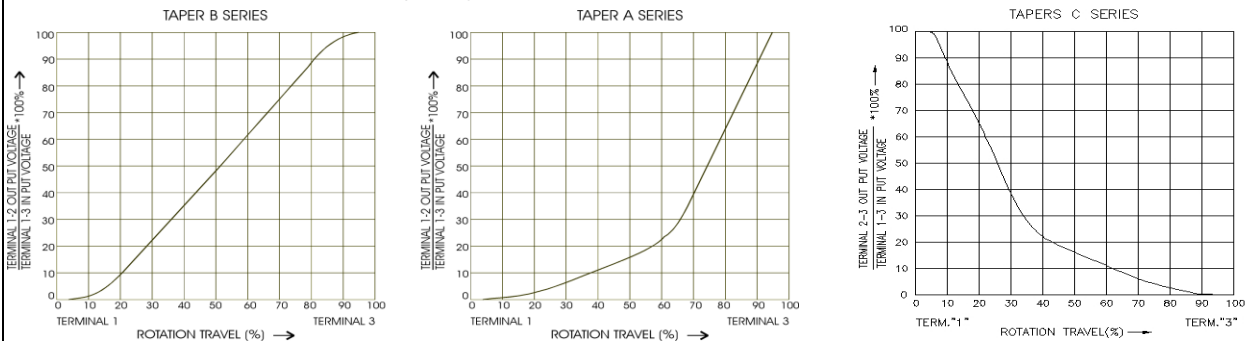

Total resistance 總阻值	10KΩ~500KΩ
Total resistance tolerance 總阻值容許差	±20% (more than 1MΩ±30%)
Max. operating voltage 最高使用電壓	B curve:50V Other than curve B:25V
Rated power 定格電力	B curve:0.05W Other than B curve:0.025W
Residual resistance 殘留阻值	$R \geq 250K\Omega$ 0.1% max. of total resistance $250K\Omega > R > 10K\Omega$ 20Ω max. $10K\Omega \geq R$ 10Ω max.
Rotational/sliding noise 迴轉/滑動雜音	Less than 100mV
Insulation resistance 絕緣抵抗	More than 100MΩ at DC 250V
Gang error 相互偏差(同步)	-40 to 0dB dB≤3dB
Manual Soldering heat 手焊錫溫度	Below 300°C, Less than 3 seconds.

Durability:耐久的性能:

Item<項目>	Performance<性能>
Rotational/sliding life 迴轉/滑動壽命	10,000 cycles (10,000 次)